

PV-ezRack[®] SolarRoof[™]

Code-Compliant Planning and Installation
Complying with AS/NZS1170.2:2011 ADMT 2-2012



CONTENT

1. Introduction.....	2
2. Planning.....	3
3. Component List.....	8
4. Array planning.....	9
5. Step by step installation.....	10
6. Service.....	18

Introduction

The Clenergy PV-ezRack[®] SolarRoof[™] has been developed as a universal PV-mounting system for roof-mounting on pitched and flat roofs. The use of patented aluminium base rails, the Z-Module technology and the telescopic mounting technology eliminates custom cutting and enables particularly fast installation.

Please review this manual thoroughly before installing PV-ezRack[®] SolarRoof[™]. This manual provides (1) supporting documentation for building permit applications relating to PV-ezRack[®] SolarRoof[™] Universal PV Module Mounting System, and (2) planning and installation instructions.

The PV-ezRack[®] SolarRoof[™] parts, when installed in accordance with this guide, will be structurally adequate and will meet the AS/NZS1170.2:2011 Admt 2-2012 standard. During installation and especially when working on the roof please comply with the appropriate occupational health and safety regulations. Please also pay attention to other relevant regulations of your local region. Please check that you are using the latest version of the installation manual, which you can do by contacting Clenergy Australia via email on sales@clenergy.com.au, or contacting your local distributor in Australia.

Planning

The installer is solely responsible for:

- Complying with all applicable local or national building codes and Clean Energy Council guidelines including any that may superseded this manual;
- Ensuring that PV-ezRack[®] SolarRoof[™] and other products you use are appropriate for the particular installation and the installation environment;
- Ensuring that the roof, its rafters, connections, and other structural support members can support the array under building live load conditions (this total assembly is hereafter referred to as the roof rafter assembly);
- Using only genuine PV-ezRack[®] parts (substitution of parts may void the warranty and invalidate the letter of certification);
- Ensuring that lag screws have adequate pull-out strength and shear capacities as installed;
- Maintaining the waterproof integrity of the roof, including selection of appropriate flashing; and
- Ensuring safe installation of all electrical aspects of the PV array

This document is designed to support for installations using PV-ezRack[®] SolarRoof[™] PV Module Mounting System, manufactured by Clenergy (Xiamen) Technology Co., Ltd. Follow the steps below and the installation instructions section to install this product in compliance with the AS/NZS1170.2:2011 ADM T 2-2012.

Before proceeding, note the following:

- This document addresses only wind loads on the assumption that wind produces the maximum load factor affecting an installation. Verify that other local factors, such as snow loads and earth quake effects, do not exceed the wind loads. Give precedence to any factor that does. Wind loads are considered to act on the entire projected area, or may be perpendicular to any surface.
- The roof on which the PV-ezRack[®] SolarRoof[™] will be installed must have the capacity to resist the combined Design Dead Load and Live Load per footing.
- To determine the parts (Bill of material) you need you can use our PV-ezRack[®] SolarRoof[™] Calculator.

1. Determine the wind region of your installation site

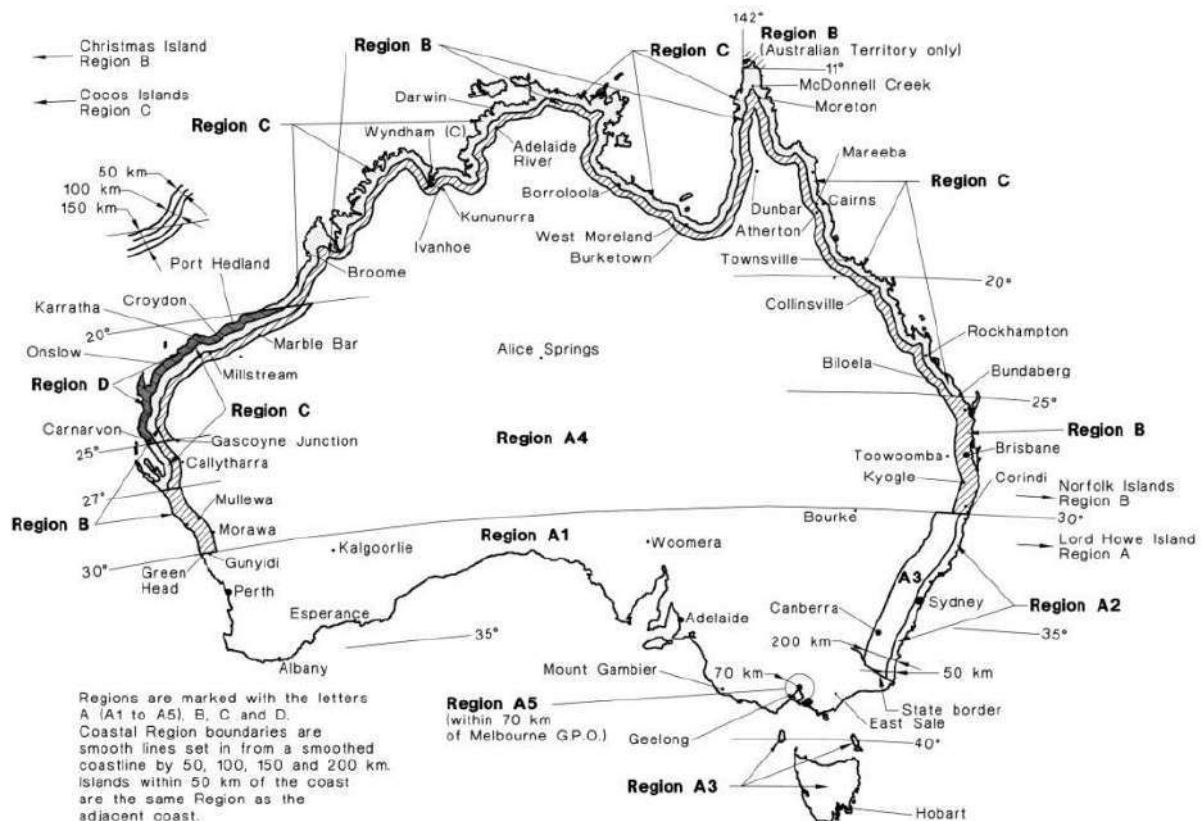

Region Definition:

Wind regions are pre-defined for all of Australia by the Australian Standard 1170.2. The Wind Region is an independent factor of surrounding topography or buildings.

- Most of Australia is designated Region A which indicates a Regional Ultimate Basic Wind Velocity of 45m/s.
- Some areas are designated Region B (57m/s). Local authorities will advise if this applies in your area.
- Region C areas (66m/s) are generally referred to as Cyclonic and are generally limited to northern coastal areas. Most Region C zones end 100km inland.
- Region D (80m/s) Australia's worst Cyclonic Region between Carnarvon and Pardoo in Western Australia.

2. Determine the Terrain Category

You will need to determine the terrain category that is most applicable to the installation.

- Terrain Category 1 (TC1) – Very exposed open terrain with few or no obstructions and enclosed, limited-sized water surfaces at serviceability and ultimate wind speeds in all wind regions, e.g. flat, treeless, poorly grassed plains; rivers, canals and lakes; and enclosed bays extending less than 10km in the wind direction.
- Terrain Category 1.5 (TC1.5) – Open Water surfaces subjected to shoaling waves at serviceability and ultimate wind speeds in all win regions, e.g. near-shore ocean water; larger unenclosed bays on seas and oceans; lakes; and enclosed bays extending greater than 10km in the wind direction. The terrain height multipliers for this terrain category shall be obtained by the linear interpolation between the values for the TC1 and TC2 in table 4.1.
- Terrain Category 2 (TC2) – Open terrain, including grassland, with well-scattered obstructions having heights generally from 1.5m to 5m, with no more than two obstructions per hectare, e.g. farmland and cleared subdivisions with isolated trees and uncut grass.
- Terrain Category 2.5 (TC2.5) – Terrain with a few trees or isolated obstructions. This category is intermediate between TC2 and TC3 and represents the terrain in developing outer urban areas scattered houses, or larger acreage developments with fewer than ten buildings per hectare. The terrain-height multipliers for this terrain category shall be obtained by linear interpolation between the values for the TC2 and TC3 in table 4.1.
- Terrain Category 3 (TC3) – Terrain with numerous closely spaced obstruction having heights generally from 3m to 10m. The minimum density f obstructions shall be at least the equivalent of 10 house sizes obstructions per hectare, e.g. suburban housing or light industrial estates.
- Terrain Category 4 (TC4) – Terrain with numerous larger, high (10m to 30m tall) and closely-spaced constructions, such as large city centres and well-developed industrial complexes.

Note: In this installation manual we have used terrain category 3, if it is outside of this please refer to the accreditation letter.

3. Determine the height of your installation site

This document provides sufficient information for the PV-ezRack[®] SolarRoof[™] system installation up to 20 meter height. If your installation site is more than 20 meters please contact Clenergy to obtain additional engineering certificate to support your installation.

4. Determine Roof slope

The PV-ezRack[®] SolarRoof[™] system can be used for roof slope up to 60 degrees. Please verify that the Installation site roof slope is between 0 and 60 degrees.

5. Determine the Maximum Rail Support Spacing

a) Tile roof

Please use the following table to determine the base rail support spacing for tile roof installations (mm).

Max PV panel dimension: 2000mm x 1000mm. Max panel weight: **15 kg/m²**.
Roof Angle: 20° ~ 60°, Terrain Category 3 (for roof pitch 30°-60° refer to accreditation letter)

10°-20° pitch

Wind Region	Building Height – H (m)		
	H≤10	10<H≤15	15<H≤20
A	1476	1253	1105
B	1025	877	777
C	655	563	501
D	418	361	322

20°-30° pitch

Wind Region	Building Height – H (m)		
	H≤10	10<H≤15	15<H≤20
A	1589	1366	1203
B	1115	952	843
C	710	610	543
D	452	390	348

- Please consult Clenergy for installing PV modules with a greater length than 2000mm or heavier than **15 kg/m²**.
- In case the wooden rafters/trusses you wish to mount on are too thin and the screws would be too close to the edge of the rafters please pre-drill with a 3-4mm pilot hole in order to avoid the splitting of the timber (or use the side mount roof hook ER-I-26).

b) Tin roof

Please use the following table to determine the base rail support spacing for sheet metal roof installations (mm).

Max PV panel length: 2000mm, Max panel weight: **15 kg/m²**,
Terrain Category 3

Roof Angle ≤ 10°

Wind Region	Building Height – H (m)		
	H≤10	10<H≤15	15<H≤20
A	1673	1602	1551
B	1521	1461	1416
C	1355	1304	1266
D	1208	1164	1131

Roof Angle 10°-20°

Wind Region	Building Height – H (m)		
	H≤10	10<H≤15	15<H≤20
A	1554	1492	1446
B	1419	1365	1324
C	1269	1222	1187
D	1134	1093	1062

Roof Angle 20°-30°

Wind Region	Building Height – H (m)		
	H≤10	10<H≤15	15<H≤20
A	1589	1525	1477
B	1449	1393	1351
C	1294	1246	1210
D	1156	1114	1083

Roof Angle 30°-60°

Wind Region	Building Height – H (m)		
	H≤10	10<H≤15	15<H≤20
A	1570	1529	1497
B	1478	1436	1404
C	1359	1311	1272
D	1214	1170	1137

- Please consult Clenergy for installing PV modules with a greater length than 2000mm or heavier than **15 kg/m²**.
- The L-Feet (ER-I-05) should be fixed to the purlins under using one 12g (6mm) screw through sheet metal roofs with gasket.
- The above spacing applies for fixing through thin sheet purlins (thickness ≥ 0.55mm) or a minimum embedment of 35mm into timber purlins.
- Please note that the screws provided with our products are designed for mounting in to wooden structures (10TPI). Clenergy recommend using 12G 14TPI screws (or M6 Buildex RoofZips®) to fix to steel purlins.

General Notes

- Recommended screws:

Metal Purlins/Battens	Fasteners to use
0.55 mm – 1.5 mm	M6-11 TPI RoofZips®
1.9 mm	M6-11 TPI RoofZips® OR 12g-14 TPI Teks screws
2.4 mm and Above	12g-24 TPI Teks screws

Wood purlins and Rafter	Fasteners to use
Pine and Hardwood (35mm embedment and above)	M6-11 TPI RoofZips® OR 14g-10 TPI

- Screws minimum embedment length into timber 35 mm
- Above Spacing calculated based on 1.9mm steel purlin OR F17 Hardwood
- In wind region C and D the spacing on should be reduced as shown below.

Material	Wind Region C	Wind Region D
0.55 mm steel Batten	25%	42%
0.75 mm steel Batten	0%	5%

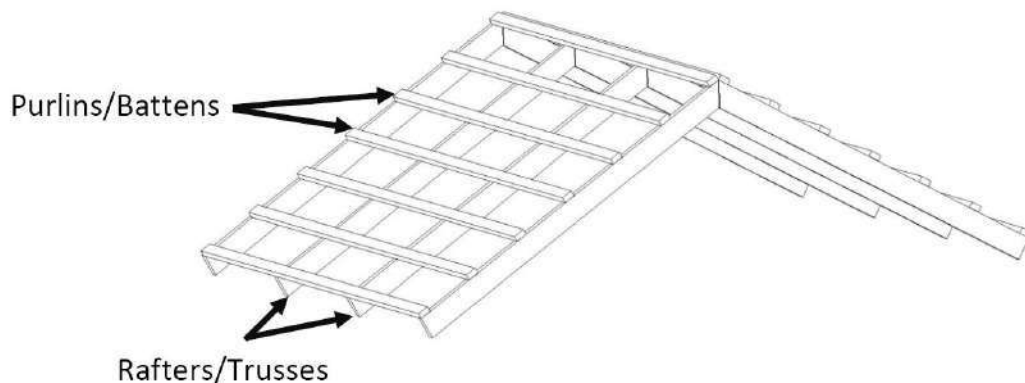







6. Verify acceptable Rail End Overhang







Rail End Overhang must equal 50% or less of foot spacing. Thus, if foot spacing is 1200 mm, the Rail End Overhang can be up to 600 mm. In this case, two feet can support a rail of as much as 2400 mm (1200 mm between the feet and 600 mm of overhang at each end).

Components List

Installation tools

- 6 mm Allen key;
- Cordless drill
- **Use ONLY stainless steel sockets**
- Open-end spanner set 9, 10, 17, 19 mm (required only for mounting with hanger bolts);
- Angle grinder with stone disk;
- Power Cord;

Overview of system components for Tile Roof			
 <p>PV-ezRack® Standard Rail</p>	 <p>PV-ezRack® Standard Splice</p>	 <p>Inter Clamp with Z-Module</p>	 <p>End Clamp with Z-Module</p>
 <p>Tile interface (Roof Hook) with Z-Module</p>	 <p>Wood screw 6x80mm</p>		

Overview of system components for Tin Roof			
 <p>PV-ezRack® Standard Rails</p>	 <p>PV-ezRack® Standard Splice</p>	 <p>Inter Clamp with Z-Module</p>	 <p>End Clamp with Z-Module</p>
 <p>Tin Interface (L-Feet) with Z-Module</p>	 <p>Wood screw 6x90mm</p>		

Preparation

Overview of system components

- a PV-ezRack[®] rails
- b Inter Clamp
- c Roof hook (Tile Interface)
- d Splice
- e End Clamp

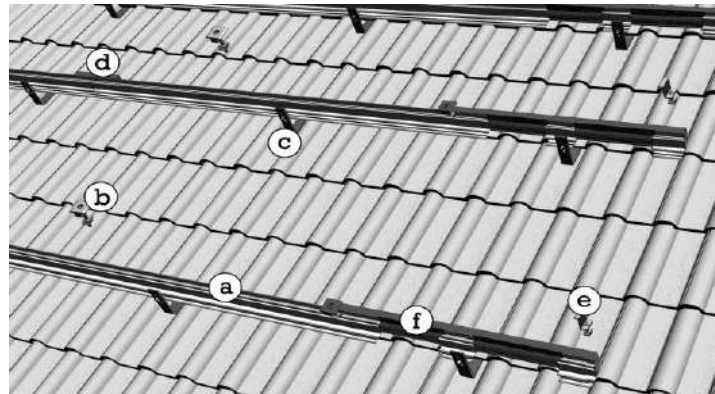

Planning the module area

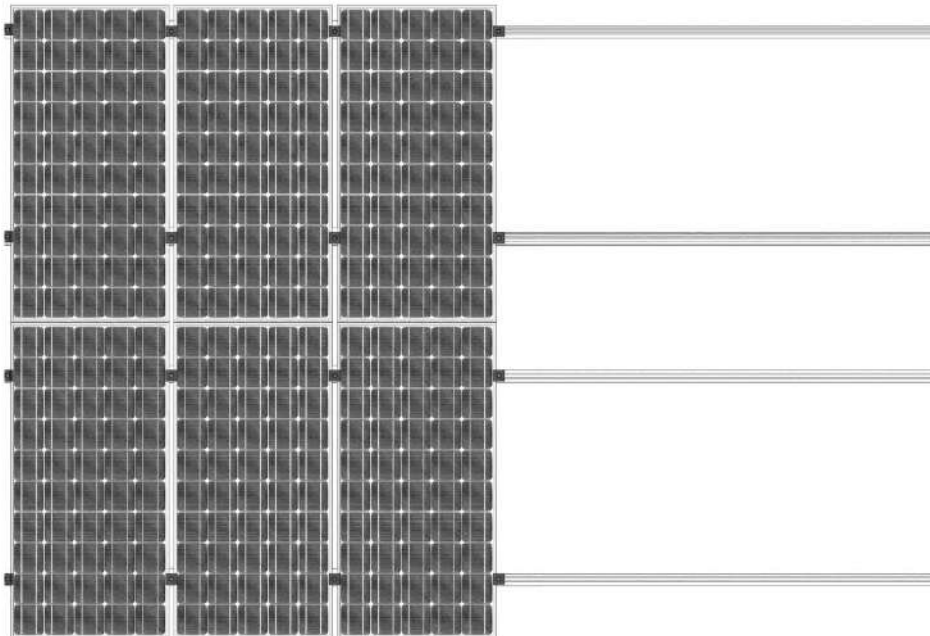

1. Number of modules in the vertical direction x module height (please check the installation manual of the Solar module manufacturer)
2. Number of modules in horizontal x (module width + 18mm) + 32mm
3. Horizontal spacing of the roof hooks up to 2.0 m
4. Vertical spacing of the roof hooks = approx. 1/2 to 3/4 of module height
5. Distance between the modules: 17 mm
6. Always check the installation manual of the PV-Module you use in order to determine the allowed fixing points on the Module frame

Step by Step Installation

Interface (Tile Roof Hook & Tin Interface) Installation

1. Determine the positions of the roof hooks according to your plans. Remove the roof tiles at the marked positions or, if possible, simply push them up slightly.



2. Fix the roof hooks to the rafter using two 6 x 80mm wood screws. **Use ONLY stainless steel sockets (using normal steel socket can result surface rust on the wood screw)**

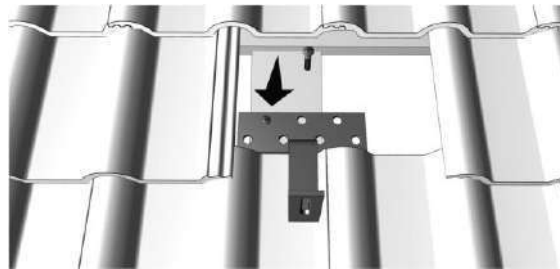

3. The roof hook must not press against the roof tile. If necessary, shim the roof hook with wood.

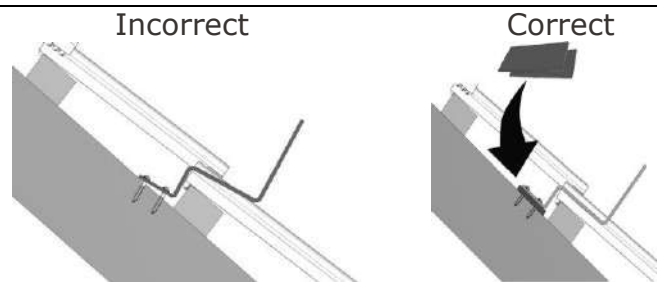

4. If necessary, use an angle grinder or hammer to cut a recess in the tile that covers the roof hook at the point where the roof hook comes through so that the tile lies flat on the surface. If grooved tiles are used, it will also be necessary to cut a recess in the lower tile. For high profile (Spanish) tiles a Roof Hook Extender can be used.

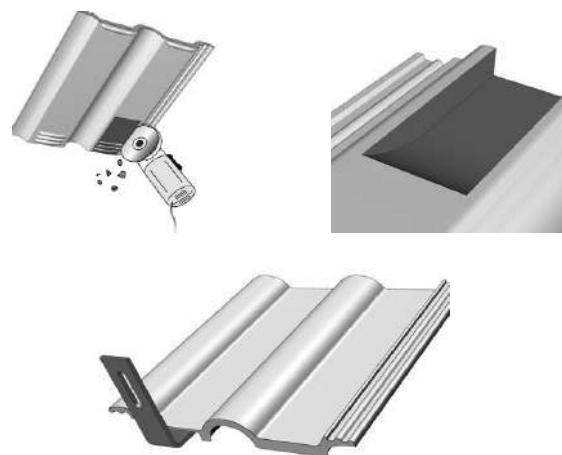

Interface (Tile Roof Hook & Tin Interface) Installation

5. Caution! Do not use fitted roof hooks as a ladder, as this extreme point load could damage the tile below.

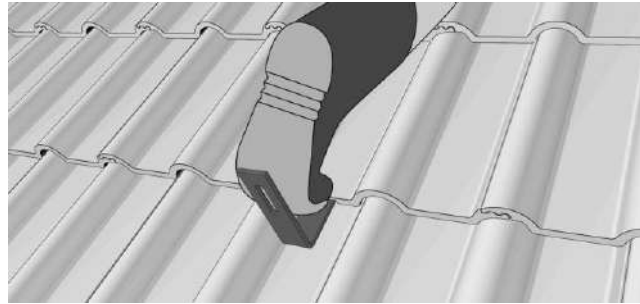

6. Variation for installation on plain tile roofs with plain tile roof cladding, a recess must be cut into the tiles around the position of the roof hook.

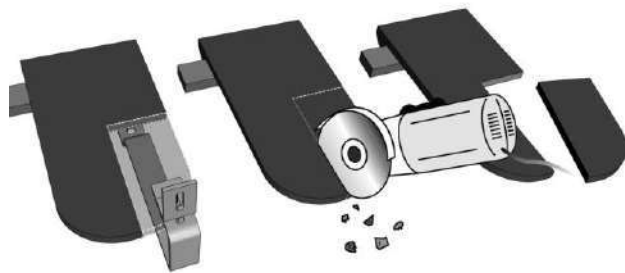

7. General Information for using Z-Module connection: to ensure easy connection of the roof hooks with the rail using the Z-Module, you should make sure that the thread of the bolt does not project through the lower side of the Z-Module (max. flush). Position the Z-Module in the rail channel and fasten it loosely with 2 to 3 turns of the bolt. The bolts can be then freely moved in the rail channel. Slide the bolts to their final and fasten firmly (recommended torque is 15-20Nm).

8. Installation of the rails on roof hooks: if the PV-ezRack[®] rails consist of different lengths, always begin with the shortest piece. Install the framing for each row of modules loosely on the roof hooks, using an M8 x 25 mm Allen bolt, washers, retaining washers and the Z-Module (2 to 3 turns of the screw are adequate for loose installation).

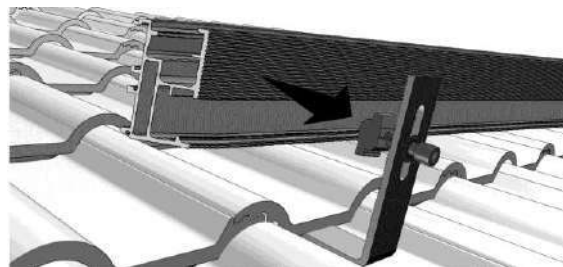

9. Adjust to necessary vertical and horizontal position by using the slot hole in the roof hooks and connection of the Z-Module or on the rail.

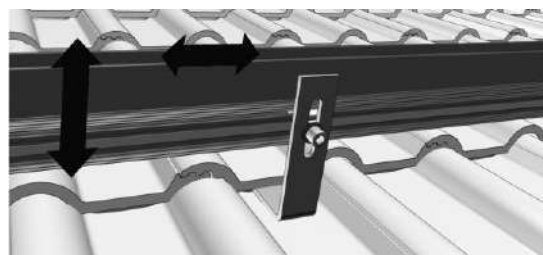

Tin Interface (L-feet) Installation

9.1. In case you need to install on corrugated tin roof cladding the Tin Interface (L-Feet) is to be used. Drill through the roof cladding at the planned location and use the supplied wood screws to fix the L-Feet to the wooden purlin. If you need to fix to metal purlin please use suitable metal screws (14TPI or Buildex[®] RoofZips[®]) with the same 6mm diameter.



9.2. Place the supplied EPDM rubber under the L-Feet in the way that the screw goes through the hole in the EPDM rubber pad. When fastening the screw make it sure that you don't deform the corrugation of the roof cladding. This can happen if you penetrate too deep with the screw when fastening.

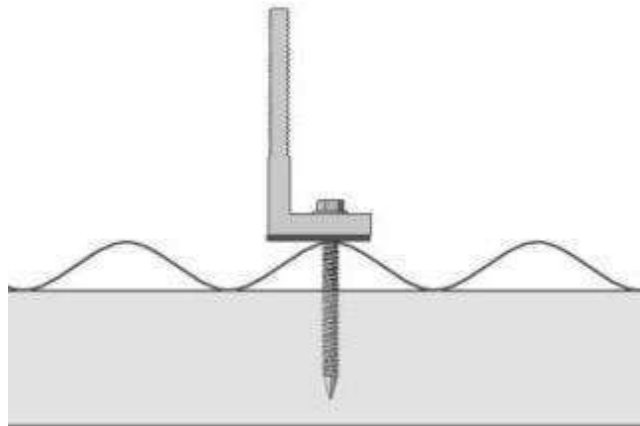

PV-Module Installation

13. Before installing the modules, add anti-slip protection to the lowest row of modules (horizontal rail installation only). To do this, fasten M6 x 20 mm bolts (with the shank downwards) to the lower mounting holes of the module frame using M6 nuts. When installing large modules M8 x 20mm bolts must be used.

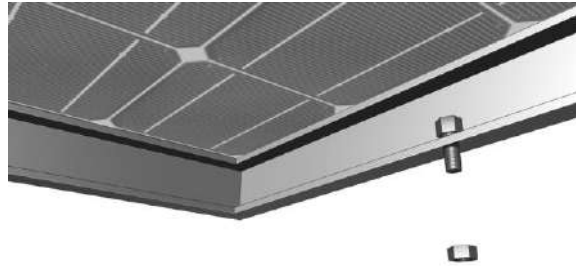

14. Place the first module of the bottom row so that the anti-slip protection sits in the rail channel of the lowest row of rails.

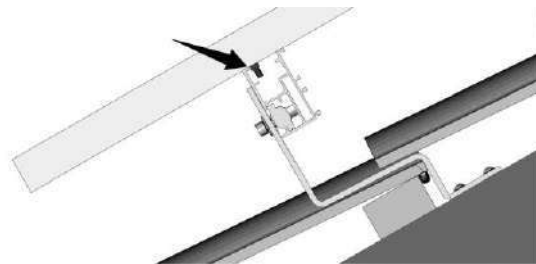

15. Slide the module end clamp tightly against the module and fasten tightly using the Allen bolt (recommended torque is 15-20Nm).

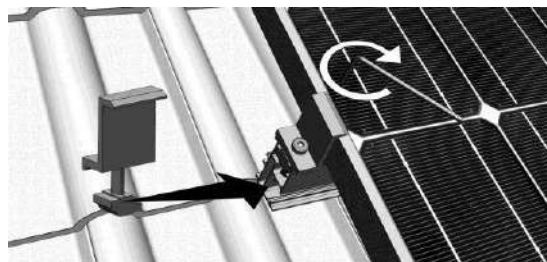

16. Cross-section through the module end clamp when installation step 15 has been correctly performed.

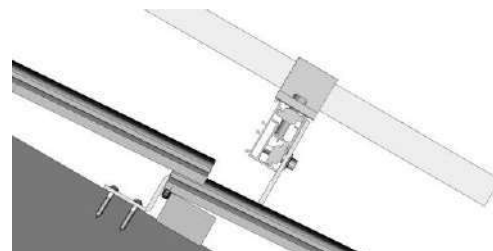

17. Insert the pre-assembled inter-module clamp into the rails from above, place it firmly against the module and fasten loosely (approx. 2 - 3 turns).

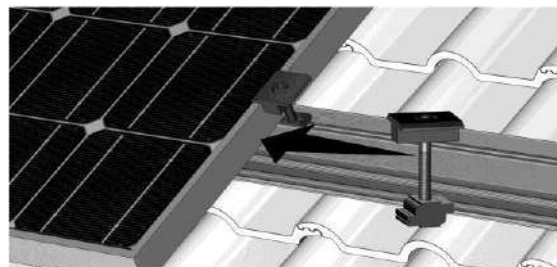

PV-Module Installation

18. Now slide the next module against the previously installed module. Ensure that the vertical side of the module frame is in contact with the vertical surface of the Inter-clamp (no gap between inter-clamp and panel). Tighten the inter-module clamp using the Allen key (recommended torque is 15-20Nm). Ensure that the anti-slip protection sits in the rail channel of the lowest row of rails.

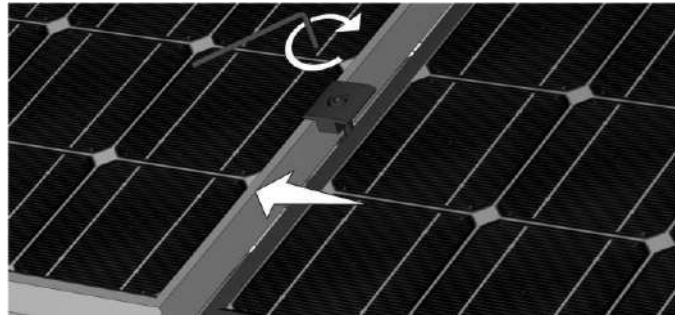

19. Place the last PV-Module in the row on the rails and fasten the last inter-module clamp and the module end-clamp using the Allen key (torque 15-20Nm).

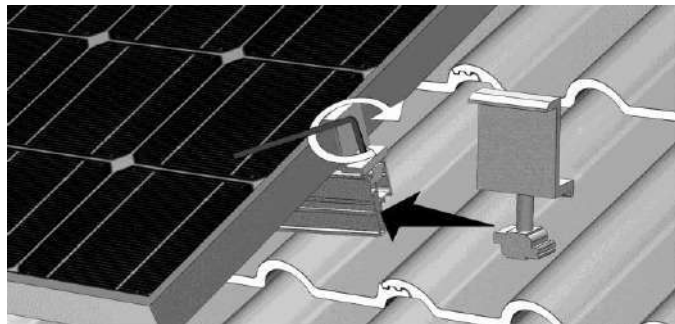

20. Now slide in the first module of the next row from above onto the corresponding PV module of the row beneath. A separation from the lower module can be maintained for optical reasons. An inter-module clamp can be used as a separator, so that the vertical and horizontal separation of the modules is identical. Continue mounting the PV-Modules as described in steps 15 to 20 until all PV modules are installed.

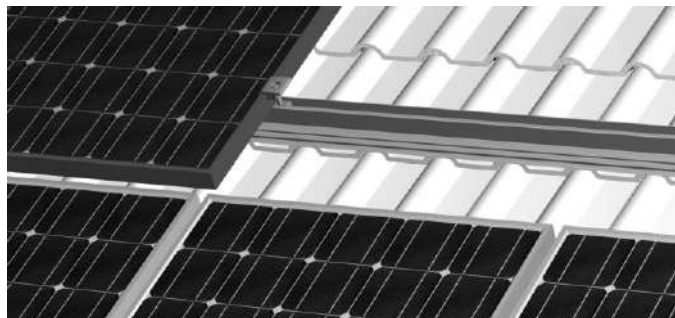

Accessories

Isolator Bracket Installation

1. Position the Z Module in the rail channel. Fix the bracket with bolt.
(Recommended bolt torque 15-20Nm)

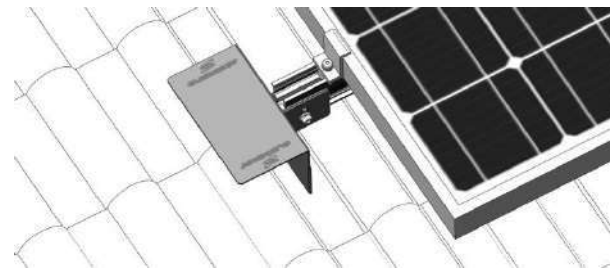
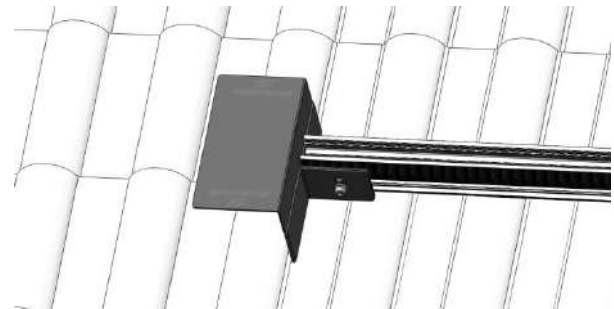
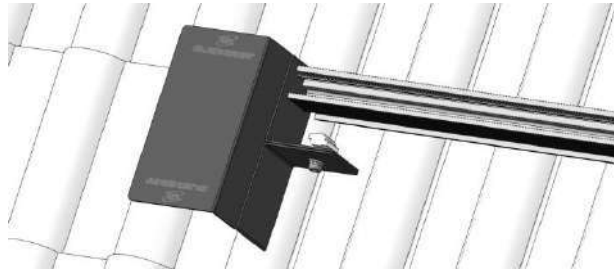

2. The final installation with the isolator mounted

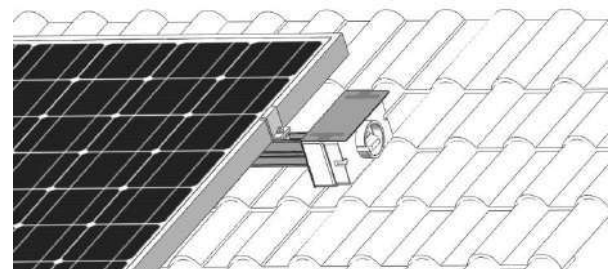
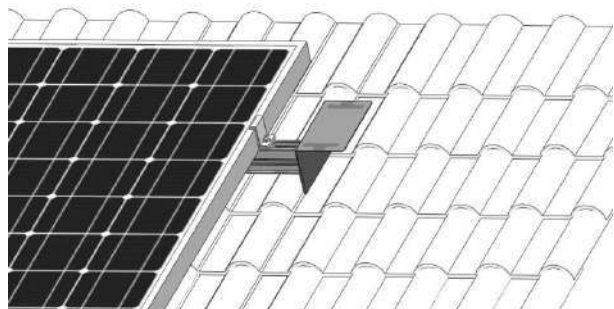

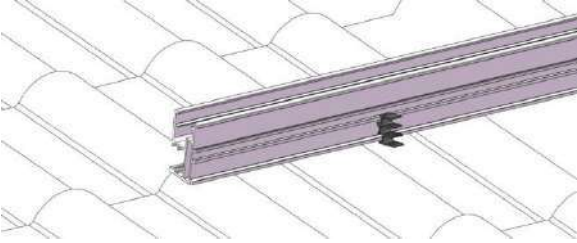
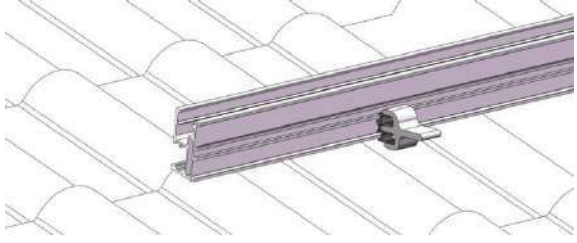
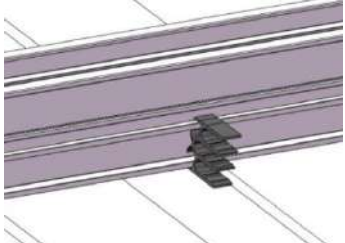
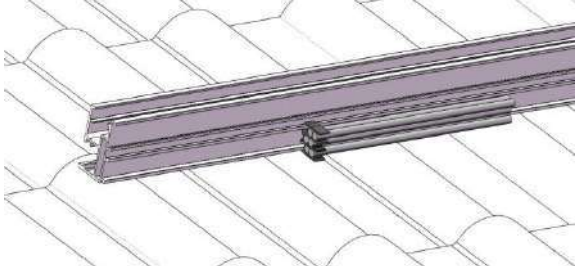
Cable Clip Installation	
<p>1. Hook the top end of clip into the groove on the back of the rail.</p>	
<p>2. Push the other end of clip in to the rail groove. You can use a rubber mallet.</p>	
<p>3. cable clip installation completed</p>	
<p>4. The cable clip can hold up to 6 PV cables.</p>	

Service

10 year limited Product Warranty, 5 year limited Finish Warranty

Clenergy co. Ltd warrants to the original purchaser ("Purchaser") of product(s) that it manufactures ("Product") at the original installation site that the Product shall be free from defects in material and workmanship for a period of ten (10) years, except for the anodised finish, which finish shall be free from visible peeling, or cracking or chalking under normal atmospheric conditions for a period of five (5) years, from the earlier of 1) the date the installation of the Product is completed, or 2) 30 days after the purchase of the Product by the original Purchaser ("Finish Warranty").

The Finish Warranty does not apply to any foreign residue deposited on the finish. All installations in corrosive atmospheric conditions are excluded. The Finish Warranty is VOID if the practices specified by AAMA 609 & 610-02 – "Cleaning and Maintenance for Architecturally Finished Aluminum" (www.aamanet.org) are not followed by Purchaser. This Warranty does not cover damage to the Product that occurs during its shipment, storage, or installation.

This Warranty shall be VOID if installation of the Product is not performed in accordance with Clenergy's written installation instructions, or if the Product has been modified, repaired, or reworked in a manner not previously authorized by Clenergy IN WRITING, or if the Product is installed in an environment for which it was not designed. Clenergy shall not be liable for consequential, contingent or incidental damages arising out of the use of the Product by Purchaser under any circumstances.

If within the specified Warranty periods the Product shall be reasonably proven to be defective, then Clenergy shall repair or replace the defective Product, or any part thereof, in Clenergy's sole discretion. Such repair or replacement shall completely satisfy and discharge all of Clenergy's liability with respect to this limited Warranty. Under no circumstances shall Clenergy be liable for special, indirect or consequential damages arising out of or related to use by Purchaser of the Product.

Manufacturers of related items, such as PV modules and flashings, may provide written warranties of their own. Clenergy's limited Warranty covers only its Product, and not any related items.